

1、 The basic wiring diagram

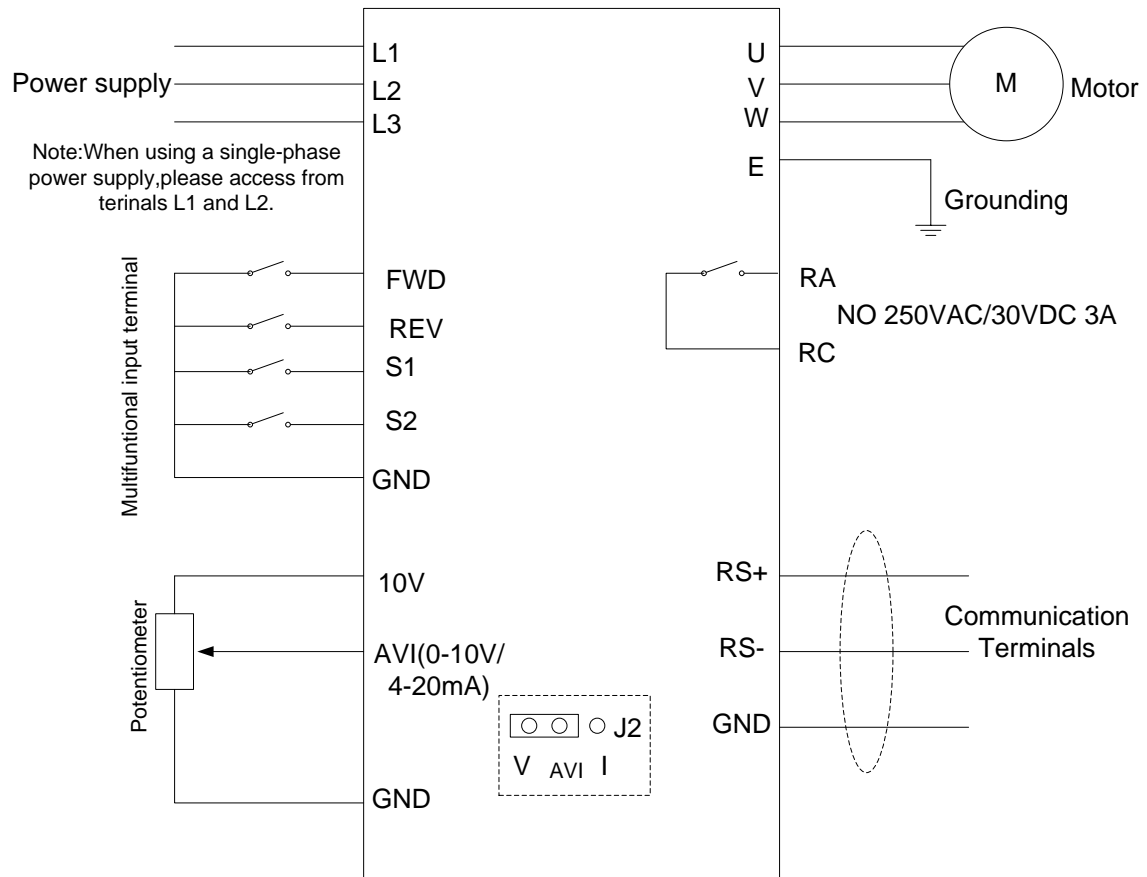

Note: AVI terminals can be used to select an analog voltage input (0-10V) and analog current input (4-20mA) through the switch J2.

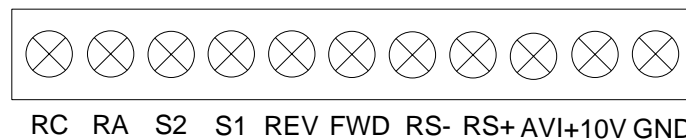

Terminal name	Function description
RS+	RS485 positive
RS-	RS485 negative

2、 Communication parameters

Initial settings and specifications of RS-485 communication

Used to perform required setting for communication between the inverter and personal computer.

P700	RS-485 Communication speed	Initial value: 0		
	Setting range	0 - 3	unit	1
	Content	0: 4800bps 1: 9600bps 2: 19200bps 3: 38400bps		

For example, the communication speed is 19200bps when the setting value is "2" .

P701	Communication mode	Initial value: 0
------	--------------------	------------------

	Setting range	0 - 5	unit	1
	Content	0: 8N1 For ASCII 1: 8O1 For ASCII 2: 8E1 For ASCII 3: 8N1 For RTU 4: 8O1 For RTU 5: 8E1 For RTU		

P701 sets the format of communication data. Please see related communication specification in detail.

P702	RS-485 communication station	Initial value: 0		
	Setting range	0 - 240	unit	1

Each inverter must have a station number, which will be defined through P702. Communication control of inverter can connect with 240 others.

If P702 is set to “ 0 “ , means communication function is invalid.

3、Communication Protocol

NL1000 series communication agreement is with MODBUS ASCII (American standard code for information inter change) mode: Each byte consists of 2 ASCII characters, for example: The expression of the numerical value of 54Hex ASCII is that “54” consists of “5” (35Hex) and 4(34 Hex).

3.1. Definition of coding

Communication agreement belongs to hexadecimal system, of which each character represents the following information.

Character	0	1	2	3	4	5	6	7
ASCII code	30H	31H	32H	33H	34H	35H	36H	37H
Character	8	9	A	B	C	D	E	F
ASCII code	38H	39H	41H	42H	43H	44H	45H	46H

3.2. Character structure

10 - Bit character box (For ASCII)

Data pattern: 8N1 For ASCII

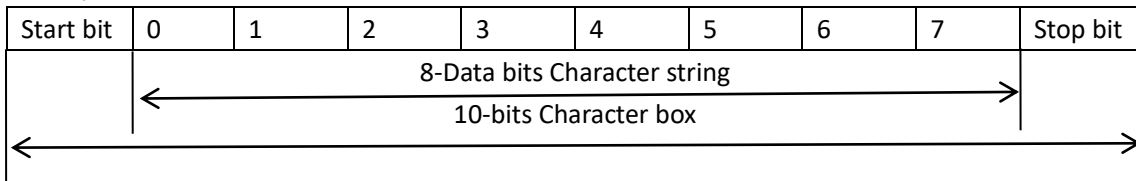

10 - Bit character box (For RTU)

Data pattern: 8N1 For RTU

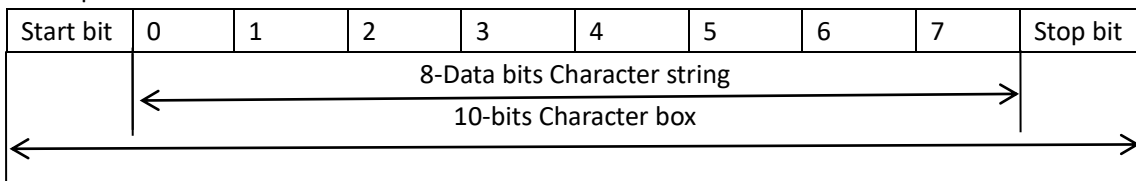

Data pattern: 8O1 For ASCII

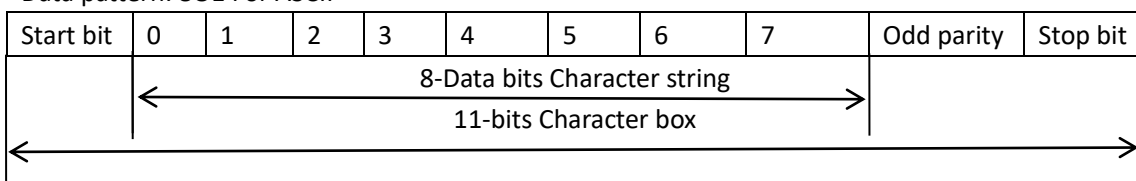

Data pattern: 8E1 For ASCII

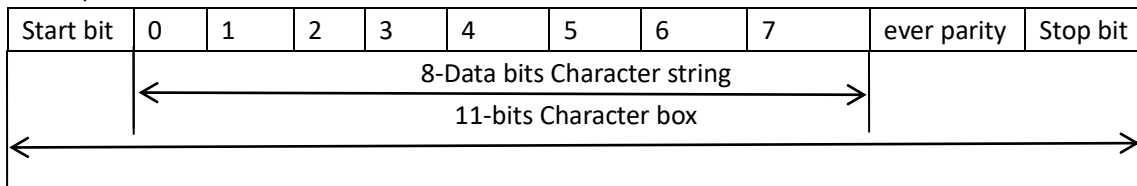

Data pattern: 8O1 For RTU

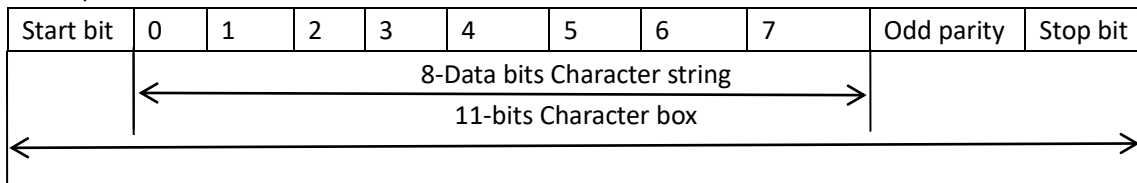

Data pattern: 8E1 For RTU

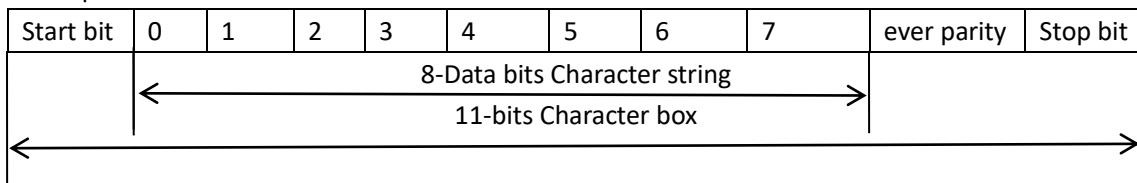

3.3. Structure of communication data

Data format box

ASCII mode:

STX	Start character = ':' (3AH)
Address Hi	Communication address:
Address Lo	8-bit address consists of 2 ASCII codes
Function Hi	Function code:
Function Lo	8-bit function code consists of 2 ASCII codes
DATA (n-1)	Data characters:
.....	$n \times 8\text{-bit data content consists of } 2n \text{ ASCII codes}$
DATA 0	$n \leq 16$, with the maximum of 32 ASCII codes
LRC CHK Hi	LRC Check:
LRC CHK Lo	8-bit LRC Check consists of 2 ASCII codes
END Hi	End character:
END Lo	END Hi = CR (0DH), END Lo = LF (0AH)

RTU mode:

START	Keep that zero-input signal is more than or equal to 10 ms
Address	Communication address: 8-bit binary address
Function	Function code: 8-bit binary address
DATA (n-1)	<p style="text-align: center;">Data characters:</p> $n \times 8\text{-bit data, } n = 16$
.....	
DATA 0	
CRC CHK Low	CRC Check:
CRC CHK High	16-bit CRC Check consists of 2 8-bit binary systems

END	Keep that zero-input signal is more than or equal to 10 ms
------------	---

Communication Address

00H: All driver Broadcasts

01H: For inverter with 01st address

0FH: For inverter with 15th address

10H: For inverter with 16th address, by analogy, the maximum could reach 240.

Function code and Data Characters

03H: Read out the content of temporary storage

06H: Write a WORD into temporary storage; Function code 03H:

Read out the content of temporary storage.

For example: Driver address 01H, reads out the data characters in 2 successive temporary storages as follows: Initial temporary storage address 2102H

Function code 06H: Write a WORD into temporary storage.

ASCII mode:

Format of enquiry message character string:

STX	‘:’
Address	0
	1
Function	0
	3
Starting address	2
	1
	0
	2
Number of data (count by word)	0
	0
	0
	2
LRC Check	D
	7
END	CR
	LF

Format of response message character string:

STX	‘:’
Address	0
	1
Function	0
	3

Number of data (count by byte)	0
	4
Content of starting address 2102H	1
	7
	7
	0
Content of address 2103 H	0
	0
	0
	0
LRC Check	7
	1
END	CR
	LF

RTU mode:

Format of enquiry message:

Address	01H
Function	03H
Starting data address	21H
	02H
Number of data (count by word)	00H
	02H
CRC CHK Low	6FH
CRC CHK High	F7H

Format of response message:

Address	01H
Function	03H
Number of data (count by byte)	04H
Content of data address 8102H	17H
	70H
Content of data address 8103H	00H
	00H
CRC CHK Low	FEH
CRC CHK High	5CH

For example: Driver address 01H, writes 6000 (1770H) into the internal setting parameter 0100H of driver.

LRC Check of ASCII mode

ASCII mode:

Format of enquiry message character string:

STX	‘:’
Address	0
	1
Function	0
	6
Data address	0
	1
	0
	0
Data content	1
	7
	7
	0
LRC Check	7
	1
END	CR
	LF

Format of response message character string:

STX	‘:’
Address	0
	1
Function	0
	6
Data address	0
	1
	0
	0
Data content	1
	7
	7
	0
LRC Check	7
	1
END	CR
	LF

RTU mode:

Format of enquiry message:

Address	01H
Function	06H
Data address	01H
	00H
Data content	17H
	70H
CRC CHK Low	86H
CRC CHK High	22H

Format of response message:

Address	01H
Function	06H
Data address	01H
	00H
Data content	17H
	70H
CRC CHK Low	86H
CRC CHK High	22H

LRC Check is the value added from Address to Data Content. For example, the LRC Check of the above 3.3.1 enquiry message is as: $01H + 03H + 21H + 02H + 00H + 02H = 29H$, then the complement of 2 (D7H) is taken.

CRC Check of RTU mode

CRC Check is from Address to Data content, and its running rule is as follows:

Step 1: Make 16-bit temporary storage (CRC temporary storage) =FFFFH.

Step 2: Exclusive OR first 8-bit byte message instruction and low 16-bit CRC temporary storage: Perform Exclusive OR, and store the result into CRC temporary storage.

Step3: Move CRC temporary storage one more bit, and fill 0 into high bit position.

Step 4: Check right shift value, if being 0, store the new value for step 3 into CRC temporary storage, otherwise in case of Exclusive OR A001H and CRC temporary storage, store the result into CRC temporary.

Step 5: Repeat Step 3 ~ Step 4, and operate completely for 8-bit.

Step 6: Repeat Step 2 ~ Step 5, and take the message instruction for next 8-bit, till all message instructions are operated completely. Finally, the value gotten of CRC temporary storage is CRC Check. It is noteworthy that, CRC Check must be placed into the check mode of message instruction interchangeably. The following is the example of CRC Check running written in C language:

```

Unsigned char data ←//Message instruction pointer
Unsigned char length ←//Length of message instruction
unsigned int crc_chk (unsigned char*data, unsigned char length)
{
int j;
unsigned int reg_crc=0XFFFF;
while( 1length--){

```

```

reg_crc^=*data ;
for (j = 0; j<?; j) {
if (reg_crc & 0x01) { /*LSB (b0) =1 */
reg_ere= (reg_crc>>1) ^0xa001;
}else{
reg_cre=reg_crc>>1;
}
}
return reg_crc; //Finally feedback the value of CRC temporary storage
}

```

Data Address	Bit Address	Content	Read /write	Address
2000H (P102=2)	BIT1~BIT0	00B: no action 01B: stop 10B: start 11B: JOG start	write	2000H
	BIT2~BIT3	00B: no action 01B: Rev 10B: Fwd 11B: change direction		
	BIT4	0B: no action 1B: reset alarm		
	BIT5~BIT15	reserved		
2001H (P101=5)	BIT0~BIT15	Freq. Command 0000~4000 1 digit after decimal point, unit :Hz	write	2001H
P027	Alarm code		read only	001BH
	BIT0	1: UC ; 0: no alarm		
	BIT1	1: oc ; 0: no alarm		
	BIT2	1: communication err.NF ; 0: no alarm		
	BIT3	1: output loss phase LO ; 0: no alarm		
	BIT4	1: OU ; 0: no alarm		
	BIT5	reserved		
	BIT6	1: LU ; 0: no alarm		
	BIT7	1: motor overload OL ; 0: no alarm		

	BIT8	1: over torque OT ; 0: no alarm		
	BIT9	1: overheat OH ; 0: no alarm		
	BIT10	1: no 4-20mA signal ; 0: no alarm		
	BIT11~BIT14	reserved		
	BIT15	1: alarm ; 0: no alarm		
P028	BIT0	0:Forward 1:Reversed	read only	001CH
	BIT1	0:stop 1:run		

4.List of Function Parameters

Function	Parameters	Name	Command address
Monitor functions	P001	Display the set frequency	0001H
	P002	Display the output frequency	0002H
	P003	Display the output current	0003H
	P004	Display the motor speed	0004H
	P005	Display the DC bus voltage value	0005H
	P006	Display the temperature of inverter	0006H
	P007	Display PID	0007H
	P009	Output voltage	0009H
	P010	Alarm record 1	000AH
	P011	Alarm record 2	000BH
	P012	Alarm record 3	000CH
	P013	Alarm record 4	000DH
	P014	The frequency setting in the last alarm	000EH
	P015	The output frequency in last alarm	000FH
	P016	The output current in last alarm	0010H
	P017	The output voltage in last alarm	0011H
	P018	The output DC bus voltage in last alarm	0012H
	P020	Output power	0014H
Basic functions	P100	Digital frequency setting	0064H
	P101	Frequency setting selection	0065H

P102	Start signal selection	0066H
P103	“stop” key lock operation selection	0067H
P104	Reverse rotation prevention selection	0068H
P105	Maximum frequency	0069H
P106	Minimum frequency	006AH
P107	Acceleration time 1	006BH
P108	Deceleration time 1	006CH
P109	V/F maximum voltage	006DH
P110	V/F base frequency	006EH
P111	V/F intermediate voltage	006FH
P112	V/F intermediate frequency	0070H
P113	V/F minimum voltage	0071H
P114	V/F minimum frequency	0072H
P115	Carrier frequency	0073H
P116	Automatic carrier line up	0074H
P117	Initialization of parameters	0075H
P118	Parameter lock	0076H
P200	Start mode selection	00C8H
P201	Stop mode selection	00C9H
P202	Starting frequency	00CAH
P203	Stopping frequency	00CBH
P204	DC injection brake operation current (start)	00CCH
P205	DC injection brake operation time (start)	00CDH
P206	DC injection brake operation current (stop)	00CEH
P207	DC injection brake operation time (stop)	00CFH
P208	Torque boost	00D0H
P209	Rated motor voltage	00D1H
P210	Rated motor current	00D2H
P211	No load current ratio of motor	00D3H
P212	Rated motor rotation speed	00D4H
P213	Number of motor poles	00D5H
P214	Rated motor slip	00D6H
P215	Rated motor frequency	00D7H

	P216	Resistance of stator	00D8H
	P217	Resistance of rotor	00D9H
	P218	Self inductance of rotor	00DAH
	P219	Mutual inductance of rotor	00DBH
I/O functions	P300	AVI minimum voltage input	012CH
	P301	AVI maximum voltage input	012DH
	P302	AVI input filter time	012EH
	P303	Reserved	012FH
	P304	Reserved	0130H
	P305	Reserved	0131H
	P306	Reserved	0132H
	P307	Reserved	0133H
	P310	Frequency of low analog	0136H
	P311	Direction of low analog	0137H
	P312	Frequency of high analog	0138H
	P313	Direction of high analog	0139H
	P314	Analog input reverse selection	013AH
	P315	Input terminal FWD (0~32)	013BH
	P316	Input terminal REV (0~32)	013CH
	P317	Input terminal S1 (0~32)	013DH
	P318	Input terminal S2 (0~32)	013EH
	P319	Reserved	013FH
	P320	Reserved	0140H
	P321	Reserved	0141H
	P322	Reserved	0142H
	P323	Reserved	0143H
	P324	Reserved	0144H
	P325	Alarm output terminal RA, RB, RC (0~32)	0145H
P326	Reserved	0146H	
P327	Reserved	0147H	
Secondary application	P400	Jog frequency setting	0190H
	P401	Acceleration time 2	0191H
	P402	Deceleration time 2	0192H
	P403	Acceleration time 3	0193H
	P404	Deceleration time 3	0194H
	P405	Acceleration time 4/Jog acceleration time	0195H

P406	Deceleration time 4/Jog deceleration time	0196H
P407	Designated value of counter	0197H
P408	Intermediate value of counter	0198H
P409	Limitation of acceleration torque	0199H
P410	Limitation of constant speed torque	019AH
P411	Over voltage prevention selection in deceleration	019BH
P412	Automatic voltage regulation selection	019CH
P413	Automatic-energy-saving selection	019DH
P414	DC Braking voltage	019EH
P415	Braking duty	019FH
P416	Restart after instant power off	01A0H
P417	Allowable time of power cut	01A1H
P418	Flank restart current limited level	01A2H
P419	Flank restart time	01A3H
P420	Fault restart times	01A4H
P421	Delay time for restart after fault	01A5H
P422	Over torque action	01A6H
P423	Over torque detection level	01A7H
P424	Over torque detection time	01A8H
P425	Reaching frequency 1	01A9H
P426	Reaching frequency 2	01AAH
P427	Timer 1 setting	01ABH
P428	Timer 2 setting	01ACH
P429	Constant-speed torque limiting time	01ADH
P430	Width of arrival of frequency in hysteretic loop	01AEH
P431	Jump frequency 1	01AFH
P432	Jump frequency 2	01B0H
P433	Jump frequency hysteresis loop width	01B1H
P434	UP/DOWN frequency step	01B2H

	P435	UP/DOWN frequency memory options	01B3H
PLC operation	P500	PLC memory mode	01F4H
	P501	PLC starting mode	01F5H
	P502	PLC running mode	01F6H
	P503	Multi-speed 1	01F7H
	P504	Multi-speed 2	01F8H
	P505	Multi-speed 3	01F9H
	P506	Multi-speed 4	01FAH
	P507	Multi-speed 5	01FBH
	P508	Multi-speed 6	01FCH
	P509	Multi-speed 7	01FDH
	P510	Multi-speed 8	01FEH
	P511	Multi-speed 9	01FFH
	P512	Multi-speed 10	0200H
	P513	Multi-speed 11	0201H
	P514	Multi-speed 12	0202H
	P515	Multi-speed 13	0203H
	P516	Multi-speed 14	0204H
	P517	Multi-speed 15	0205H
	P518	PLC operation time 1	0206H
	P519	PLC operation time 2	0207H
	P520	PLC operation time 3	0208H
	P521	PLC operation time 4	0209H
	P522	PLC operation time 5	020AH
	P523	PLC operation time 6	020BH
	P524	PLC operation time 7	020CH
	P525	PLC operation time 8	020DH
	P526	PLC operation time 9	020EH
	P527	PLC operation time 10	020FH
	P528	PLC operation time 11	0210H
	P529	PLC operation time 12	0211H
P530	PLC operation time 13	0212H	
P531	PLC operation time 14	0213H	
P532	PLC operation time 15	0214H	
P533	PLC operation direction	0215H	
PID operation	P600	PID starting mode	0258H
	P601	PID operation mode selection	0259H
	P602	PID action set point	025AH
	P603	PID feedback value selection	025BH
	P604	PID figure target value setting	025CH

	P605	PID upper limit alarm value	025DH
	P606	PID lower limit alarm value	025EH
	P607	PID proportional band	025FH
	P608	PID integral time	0260H
	P609	PID differential time	0261H
	P610	PID action step-length	0262H
	P611	PID standby frequency	0263H
	P612	PID standby duration	0264H
	P613	PID wake-up value	0265H
	P614	PID corresponding value of display	0266H
	P615	PID digit of display	0267H
	P616	PID decimal digits of display	0268H
	P617	PID upper limit frequency	0269H
	P618	PID lower limit frequency	026AH
	P619	PID working mode	026BH
Advanced application	P800	Advanced application parameter lock	0320H
	P801	System 50Hz/60Hz setting	0321H
	P802	Constant torque or variable torque selection	0322H
	P803	Over-voltage protection setting	0323H
	P804	Under-voltage protection setting	0324H
	P805	Over-temperature protection setting	0325H
	P806	Current display filter time	0326H
	P807	0-10V analogue output low end calibration coefficient	0327H
	P808	0-10V analog output high end calibration coefficient	0328H
	P809	0-20mA analogue output low end calibration coefficient	0329H
	P810	0-20mA analog output high end calibration coefficient	032AH
	P811	Compensation frequency point for dead time	032BH
P812	UP/DOWN frequency memory options	032CH	